

Concrete Mixer Supply.com

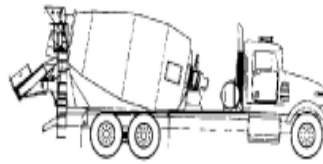

Mixer Parts

ELECTRICAL

Concrete Mixer Supply.Com

SECTION 9

Electrical

Components

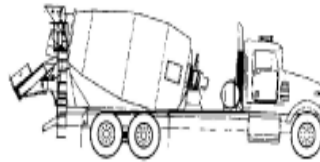

**SMITH CAB CONTROL
& ROCKER SWITCHES**

ELECTRICAL

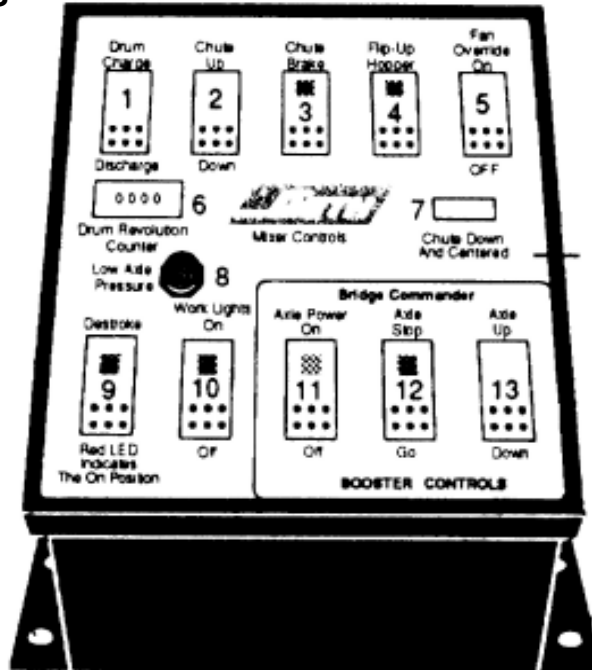

| <u>Item#</u> | <u>CMS #</u> | <u>OEM Part#</u> | <u>Description of Part</u> |
|--------------|--------------|------------------|-------------------------------------|
| 1 | CSW 1027 | 55000501 | Momentary Switch On-Off-On |
| 2 | CSW 1027 | 55000501 | Momentary Switch On-Off-On |
| 3 | CSW 1026 | 55000502 | On-Off with Red LED |
| 4 | CSW 1026 | 55000502 | On-Off with Red LED |
| 5 | CSW 1030 | 55000505 | On-Off |
| 6 | CT1004 | 43788000 | Drum Revolution Counter - Prox |
| 7 | CSW 1031 | 55000507 | Green Indicator Light |
| 8 | CSW 1032 | 3257006 | Indicator Light - Low Axle Pressure |
| 9 | CSW 1026 | 55000502 | On-Off with Red LED |
| 10 | CSW 1026 | 55000502 | On-Off with Red LED |
| 11 | CSW 1028 | 55000503 | On-Off with Green LED |
| 12 | CSW 1029 | 55000504 | On-None-On with Green LED |
| 13 | CSW 1030 | 55000505 | On-Off |

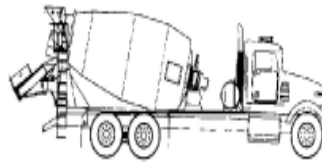

SMITH RED HANDLE
CONTROL & SWITCHES

ELECTRICAL

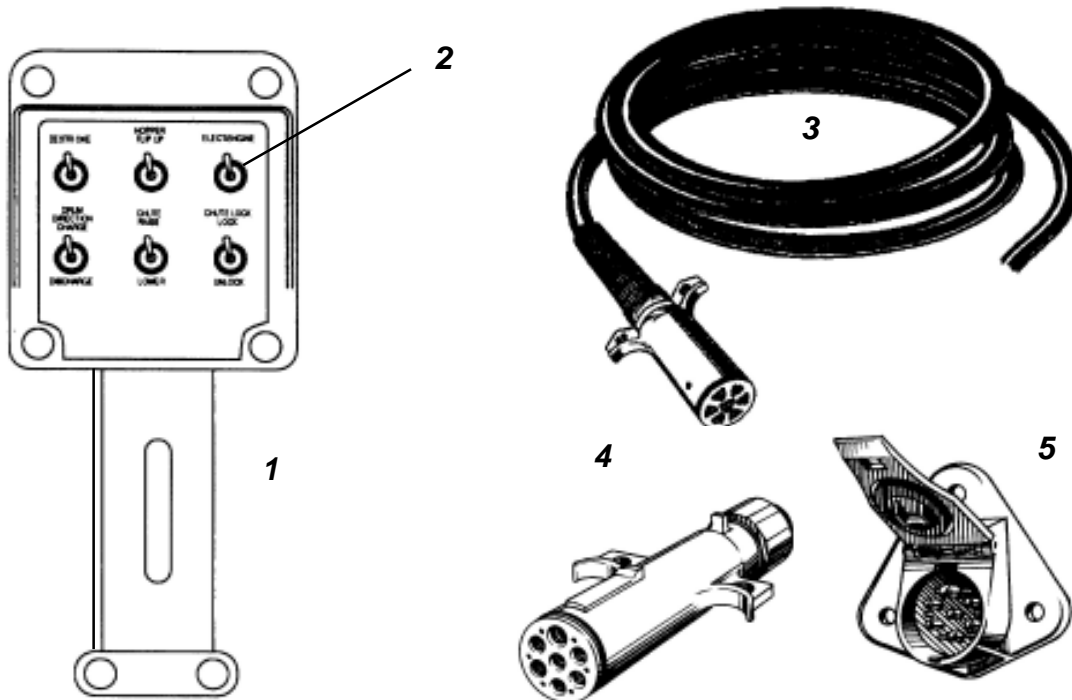

| <u>Item#</u> | <u>CMS #</u> | <u>OEM Part#</u> | <u>Description of Part</u> |
|--------------|--------------|------------------|---|
| 1 | CSW 1009 | 26680010 | Red Handle Assy 3 Switch 25 Foot Lead with Cole Hersee Plug |
| 1 | CSW 1009 A | 55000212 | Red Handle Assy 6 Switch 25 Foot Lead with Cole Hersee Plug |
| 1 | CSW 1009 B | 520-010015 | Red Handle Assy 6 Switch 25 Foot Lead with Ring Terminal Ends |
| 2 | CSW 1000 | 3261000 | On Off Switch Sealed No Leads |
| 2 | CSW 1001 | 26602 | Momentary Switch Sealed No Leads |
| 2 | CSW 1002 | 060.16977P | On Off Switch Sealed with Leads |
| 2 | CSW 1003 | 060.85693 | Momentary Switch Sealed with Leads |
| | CSW 1001 A | | Switch Rubber Boot |
| 3 | ELC018-2 | 060.00689 | 18/2 Cable |
| 3 | ELC018-3 | 060.00688 | 18/3 Cable |
| 3 | ELC018-8 | 060.110166 | 18/8 Cable |
| 3 | ELC018-14 | | 18/14 Cable |
| 4 | CSW 1012 | 00944005 | Cole Hersee Plug |
| 5 | CSW 1013 | 00944004 | Cole Hersee Socket |
| 6 | CSW 1014 B | | Flex Strain Relief |

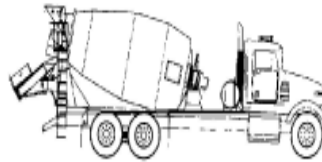

McNeilus Cab Control

ELECTRICAL

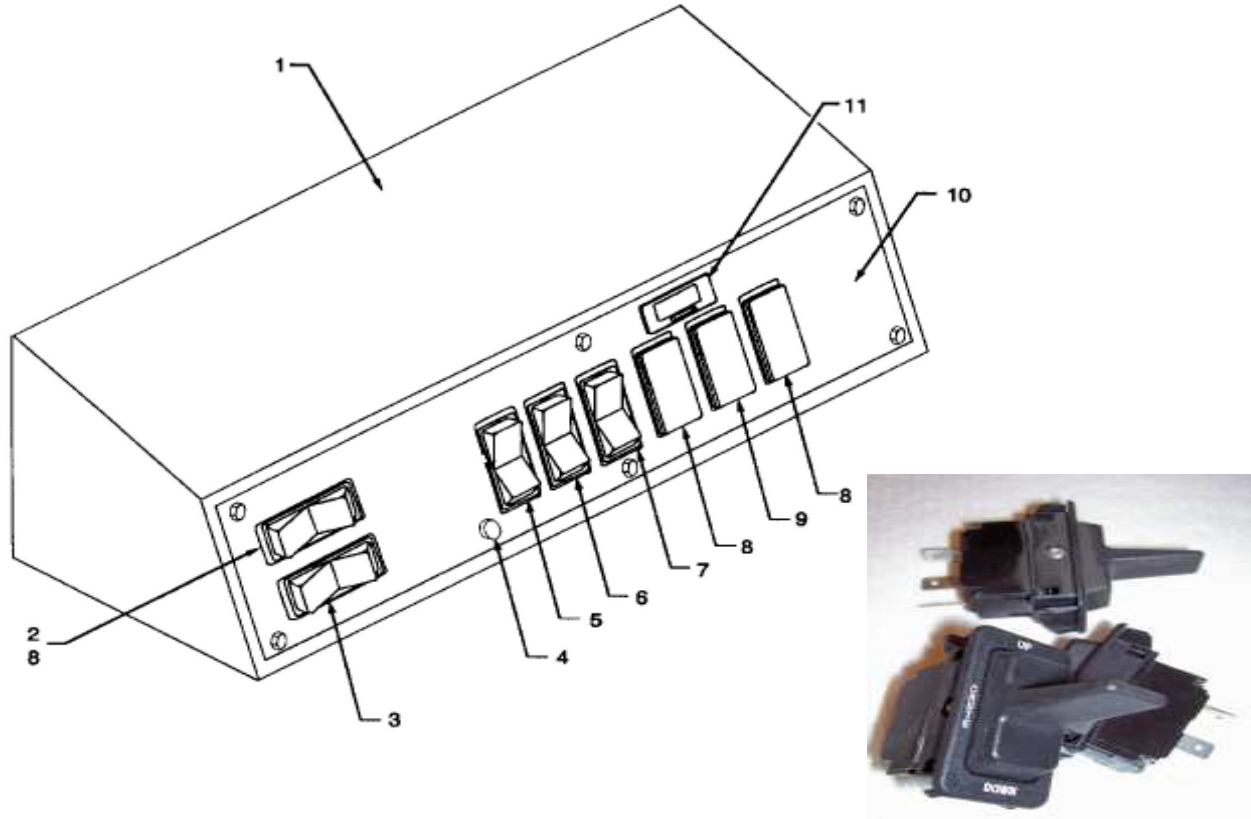

| <u>Item#</u> | <u>CMS #</u> | <u>OEM Part#</u> | <u>Description of Part</u> |
|--------------|--------------|------------------|---------------------------------|
| 1 | CON 2010 | 280.153913 | Cab Control Box without Handle |
| 1 | CON 2011 | 280.153902 | Cab Control Box with Handle |
| 2 | CSW 1017 | 060.110256 | Switch, Charge/Discharge |
| 3 | CSW 1010 | 060.110253 | Switch, Start/Stop |
| 4 | CON 2010 K | 060.106646 | Light |
| 5 | CSW 1007 | 060.110255 | Switch, Chute Up/Down |
| 6 | CSW 1008 | 060.110258 | Switch, Chute Lock |
| 7 | CSW 1011 | 060.110257 | Switch, Hopper Up |
| 8 | CON 2010 A | 060.110150 | Bezel, Small |
| 9 | CSW 1016 | 060.110254 | Switch, Work Light |
| 10 | CON 2010 B | 780.153953 | Standard Switch Plate |
| 11 | CT 1004 | 060.110173 | Drum Revolution Counter Digital |
| 12 | CON 2010 G | 280.152903 | Fuse |
| 13 | CON 2010 H | 780.214690 | Decal |
| 14 | CON 2010 J | 060.189251 | Panel Harness |

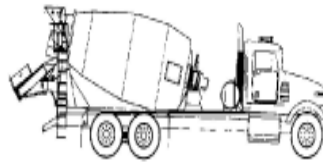

ELECTRICAL

McNeilus Cab Switches

060.110112
Momentary
2 Prong
CSW1044

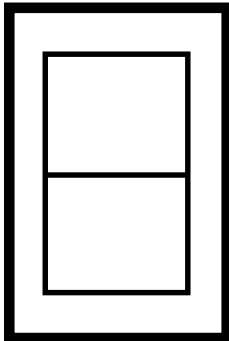

060.110113
Momentary
3 Prong
CSW1043

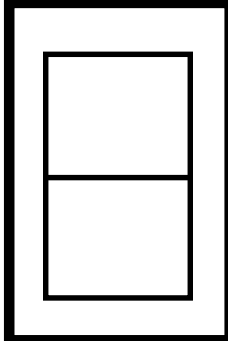

060.110114
On - Off
5 Prong
CSW1042

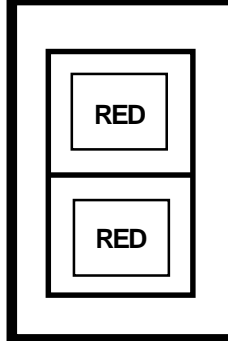

060.110115
On - Off
3 Prong
CSW1041

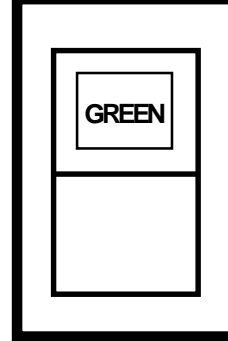

060.110116
On - Off
3 Prong
CSW1040

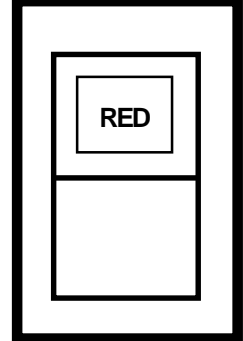

060.110155
Momentary
3 Prong Paddle
CSW1039

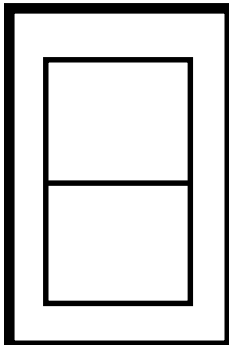

060.110250
Momentary
3 Prong
CSW1038

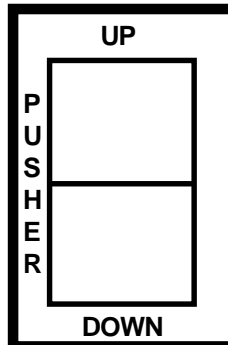

060.110251
Momentary
3 Prong
CSW1037

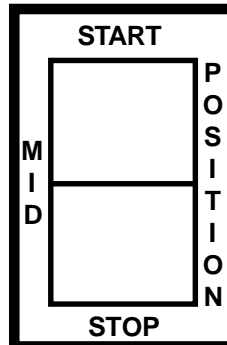

060.110252
Momentary
3 Prong
CSW1036

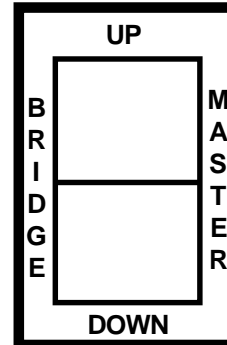

060.110253
On-Off 5 Prong
CSW 1010

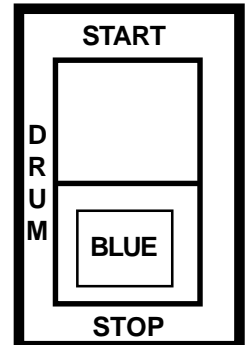

060.110254
On - Off 3 Prong
CSW 1016

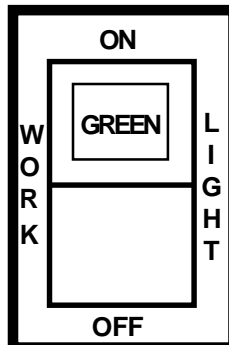

060.110255
3 Prong Paddle
CSW 1007

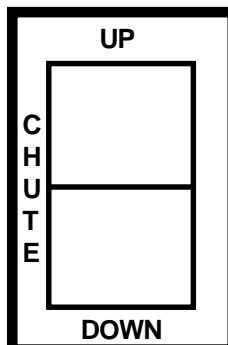

060.110256
3 Prong Paddle
CSW 1017

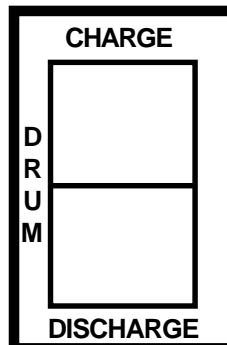

060.110257
On - Off 5 Prong
CSW 1011

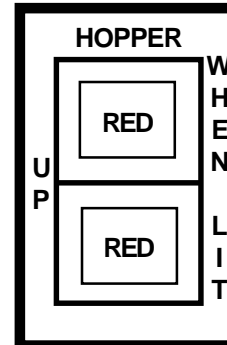

060.110258
On - Off 5 Prong
CSW 1008

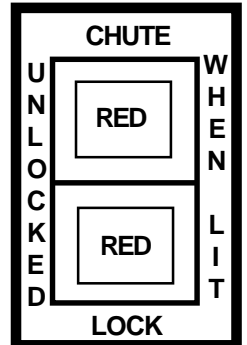

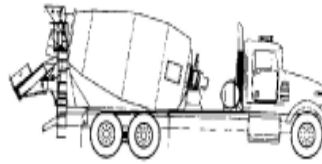

ELECTRICAL

McNeilus Cab Switches

060.110259
Momentary
4 Prong
CSW1034

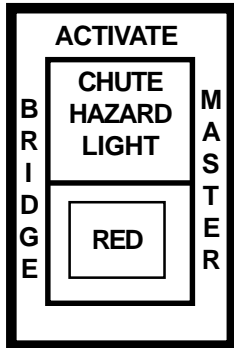

060.110260
Momentary
3 Prong
CSW1035

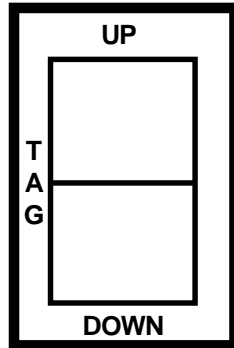

060.110262
Momentary
6 Prong
CSW1033

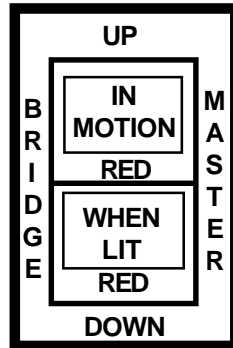

550000507
Green Light
2 Prong-CSW 1031



060.110124
Red Light
2 Prong - CSW 1031 A



Work Light Assembly Kit CMS Part # LT 1050

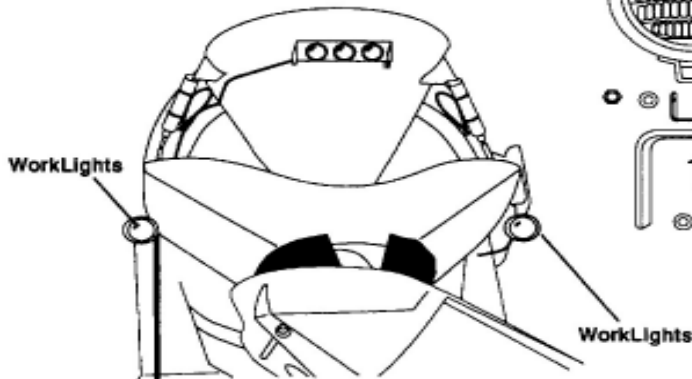

SMITH FENDER LIGHT KIT CMS Part # LT 1019

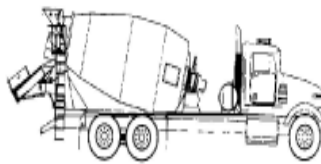

ELECTRICAL

Pendant

108051

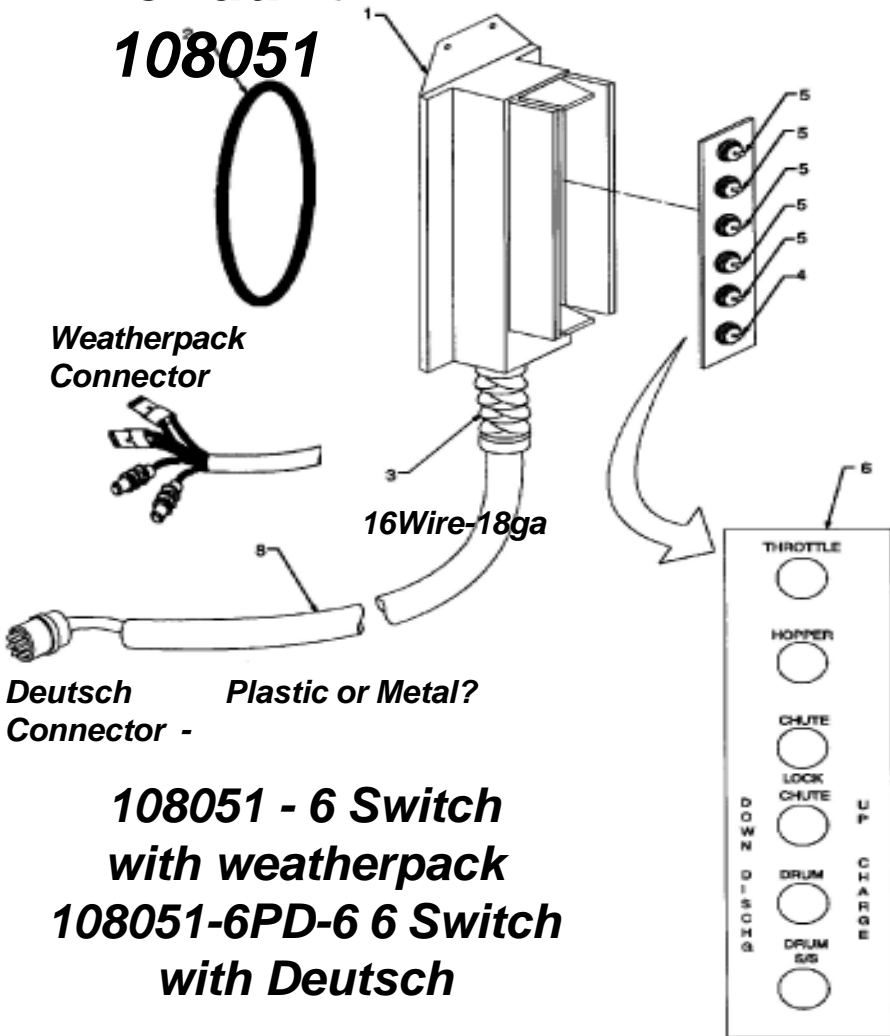

Weatherpack
Connector

16Wire-18ga

Deutsch Connector - Plastic or Metal?

108051 - 6 Switch with weatherpack
108051-6PD-6 6 Switch with Deutsch

#4 - CSW1002 On/Off Switch with Leads 060.16977P



#5 - CSW1003 Momentary Switch with Leads 060.85693

| <u>Item#</u> | <u>CMS #</u> | <u>OEM Part#</u> | <u>Description of Part</u> |
|--------------|--------------|------------------|------------------------------|
| 1 | CSW 2000 | 320.110233 | Rear Pendant |
| 2 | CSW 2000 A | 100.110234 | O Ring |
| 3 | CSW 2000 B | 060.110205 | Strain Relief |
| 4 | CSW 1002 | 060.128730 | Toggle Switch On/Off |
| 5 | CSW 1003 | 060.189136 | Toggle Switch Momentary |
| 6 | CSW 2000 E | 780.214652 | Decal |
| 8 | CSW 2000 G | 060.189138 | 25 Foot Rear Pendant Harness |
| 8 | CSW 2000 H | 060.189164 | 4 Foot Harness |

Important information when ordering 108051 Remote Control - What year is the McNeilus Truck Mixer built? _____ How many pins are "used" in the connector? _____ Deutsch connector(round) - Is it plastic or metal? _____

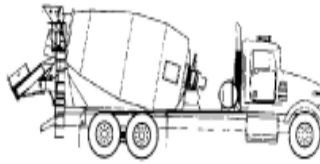

ELECTRICAL

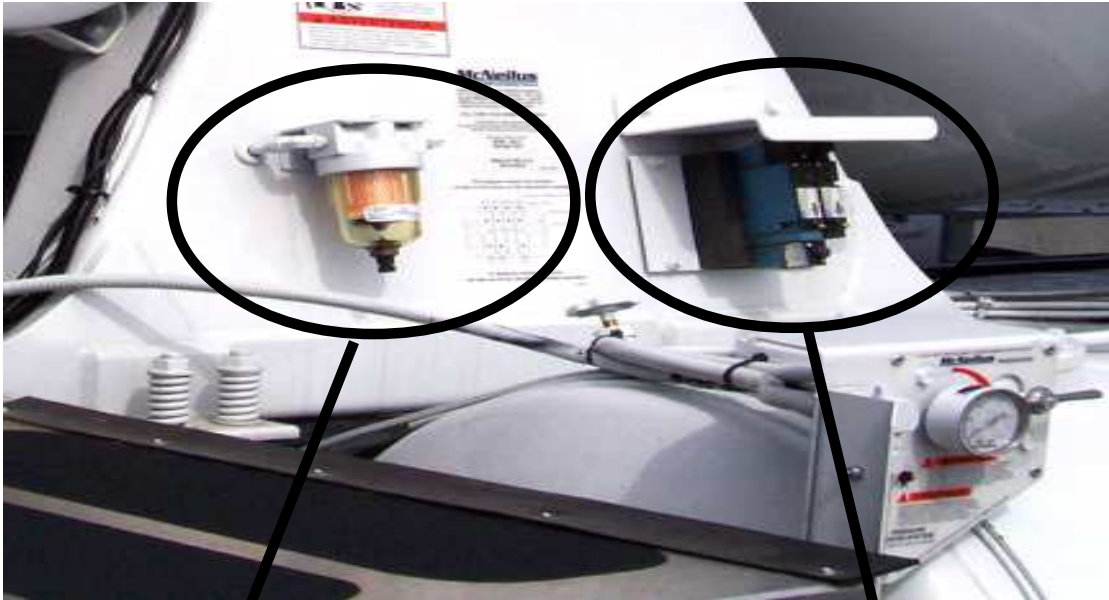

140.121414 Filter Assembly

- McNeilus MAC Valves**
- 1138152 Chute Lock Valve**
- 1138153 Hopper Up Valve**
- 1138154 Aux Axle Valve**



- McNeilus MAC Valves**
- CL1015 85284 Chute Lock**
- CL1016 85288 Hopper Up**

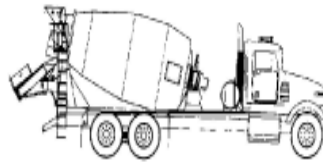

ELECTRICAL

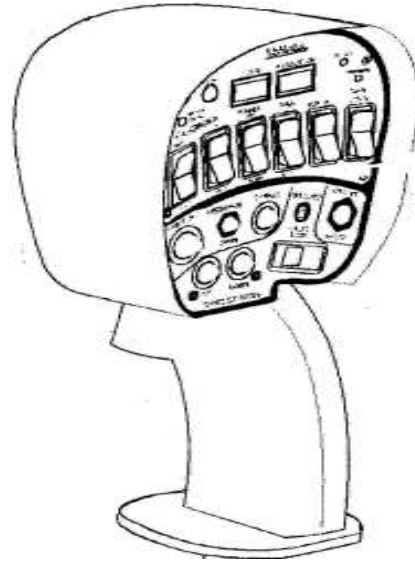
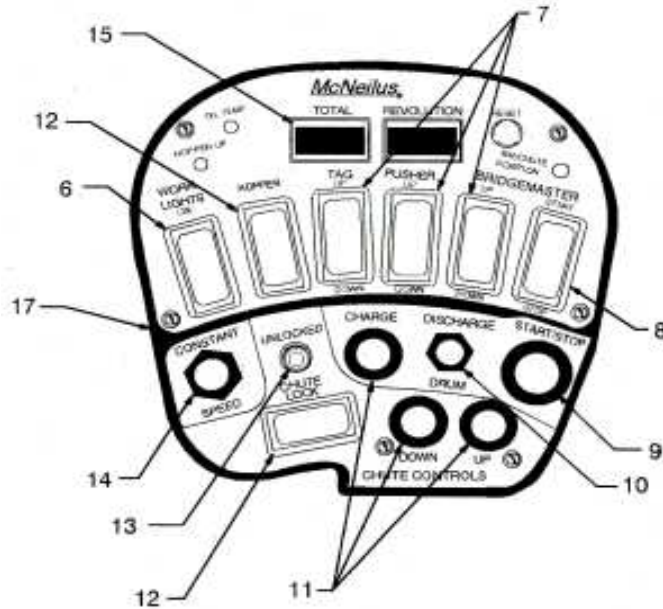

- #7 060.189117 Rocker Switch Mixer Proximity Switches**
- #8 1103579 Rocker Switch**
- #9 1145137 Push Button**
- #10 1155959 Button Discharge**
- #11 060.189123 Push Button**
- #12 1102875 Rocker Switch**
- #13 060.189119 Light**
- #14 1145138 Push Button**



- CT1000 110198 2 Wire Prox**
- CT1001 110172 3 Wire Prox with weatherpack**
- CT1001A 1109629 3 Wire Short Body w weatherpack**
- CT1000B 110201A 4 Wire Prox w weatherpack**

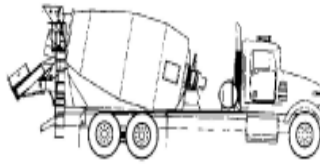

ELECTRICAL

Back Up Alarm Kit

**CMS Part #
ELC 2000**



SWITCH SEALS (BOOTS)

**CMS Part #
CSW1000A**



**SEALED SWITCHES
CSW1000 ON/OFF
CSW1001 MOMENTARY**



Concrete Mixer Supply.com

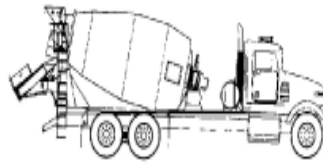

Mixer Parts

ELECTRICAL
LONDON REAR CONTROL HANDLES
MC-40000-41 6 SWITCH



www.concretemixersupply.com
9-11

877-254-0715

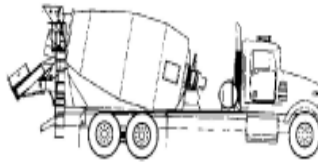

MC-40000

LONDON MULTI SWITCH ELECTRICAL
YELLOW HANDLE ASSEMBLY

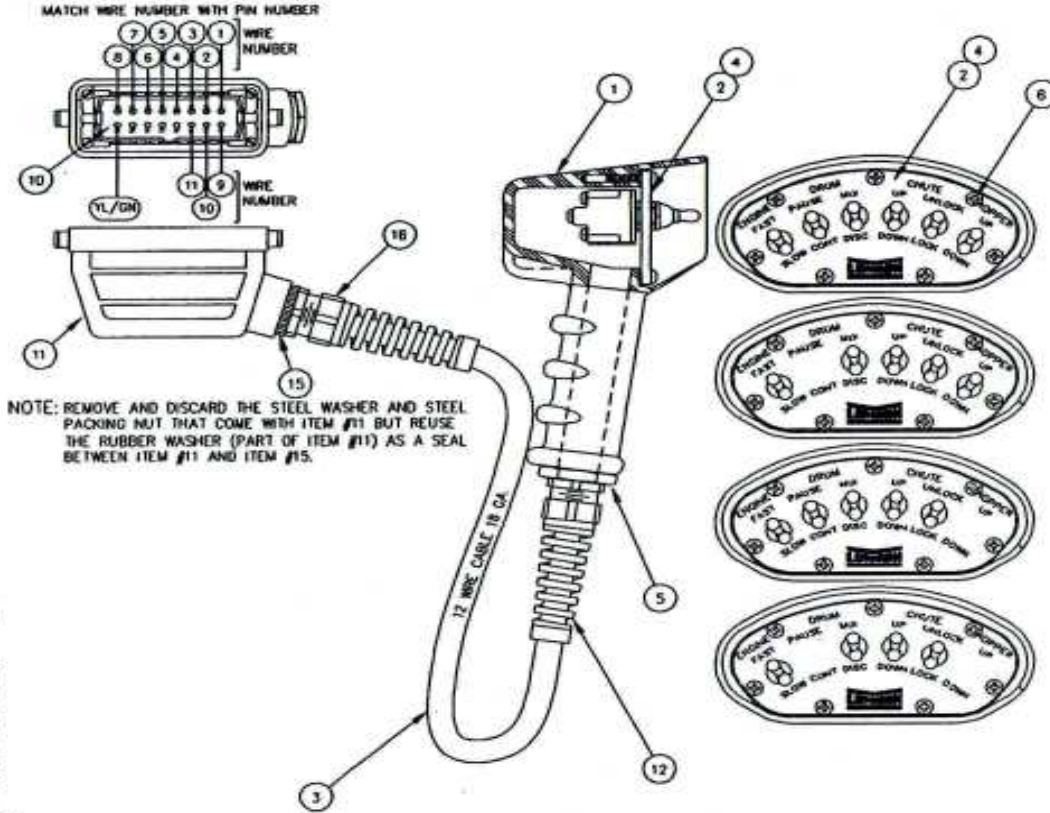

| ITEM | DESCRIPTION | QTY. | PART No. |
|------|------------------------------|------|--------------|
| 1 | Multi Switch Handle | 1 | MC-39741 |
| 2 | Multi Switch Face Plate | 1 | MB-39739-** |
| 3 | 12 Wire Cable 18 GA. - 20ft. | 1 | HH-01244-012 |
| 4 | Face Plate Gasket | 1 | MB-39740 |
| 5 | Reducer 3/4-1/2 NPT Black | 1 | HH-01185-005 |
| 6 | St.Steel Screw #6-3/4" Lg. | 7 | HH-00455-007 |
| 7 | Micro Switch | * | MA-38416 |
| 8 | Micro Switch | * | MA-26602 |
| 9 | Rubber Boot - Switch | * | MM-26603 |
| 10 | Male Plug | 1 | MA-39997 |
| 11 | Cover Plug Mount | 1 | MA-39999 |
| 12 | Flex Cord Grip 1/2 NPT Black | 1 | HH-01224-012 |
| 13 | Eyelet, 18 GA. 6 Stud | * | HH-00803-001 |
| 14 | Red Wire, 16 GA. | A/R | HH-00836-001 |
| 15 | Reducer Bushing | 1 | HH-01245-013 |
| 16 | Flex Cord Grip | 1 | HH-01246-030 |

* Refer to Chart, A/R = as required.

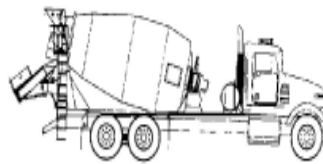

LONDON MULTI SWITCH
YELLOW HANDLE ASSEMBLY **ELECTRICAL**



MA-39998
Base Plug Mount



MB-40728
Junction Box Machined



MA-39997
Male Plug



MA-39996
Female Plug



MA-39999 London
Handle Cord Cover

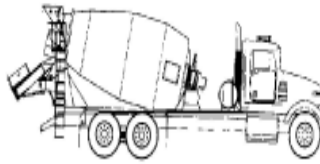

ELECTRICAL

CON2000AK YELLOW HANDLE SINGLE SWITCH 25FT CORD

CON2000BK YELLOW HANDLE DOUBLE SWITCH 25FT CORD



CSW1000 ON/OFF SWITCH (SCREWS)

CON2000 YELLOW HANDLE BLANK

CSW1001 MOMENTARY SWITCH (SCREWS)

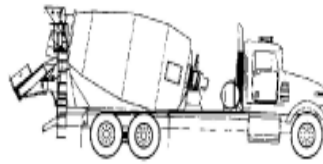

CON2000BK

2 SWITCH LONDON HANDLE

ELECTRICAL

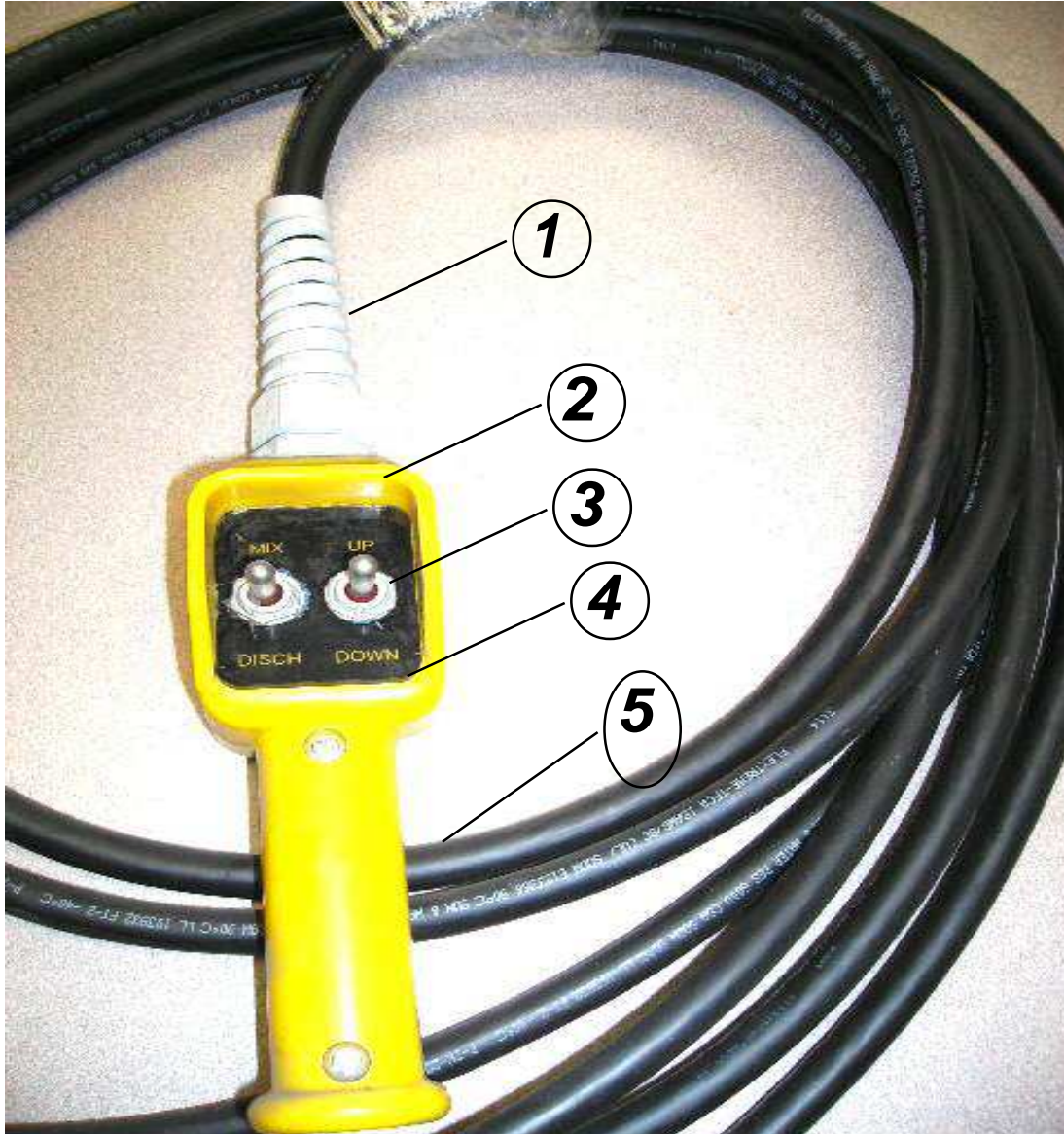

| ITEM # | PART # | DESCRIPTION | QTY |
|--------|--------------|-----------------------------|------|
| 1 | HH-01224-012 | FLEX STRAIN RELIEF | 1 |
| 2 | CON2000A | YELLOW HANDLE BLANK | 1 |
| 3 | CSW1000 | On/Off TOGGLE SWITCH | 1 |
| 3a | CSW1001 | MOMENTARY TOGGLE SWITCH | 1 |
| 4 | MA-38422 | 2 SWITCH FACE PLATE | 1 |
| 5 | ELCON18-8 | ELECTRIC CABLE 18awg/8 wire | 25FT |

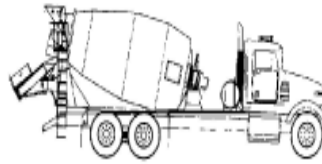

ELECTRICAL

MB-39739
LONDON MULTI SWITCH
FACE PLATE



MA-38422
LONDON 2 SWITCH
YELLOW HANDLE
FACE PLATE

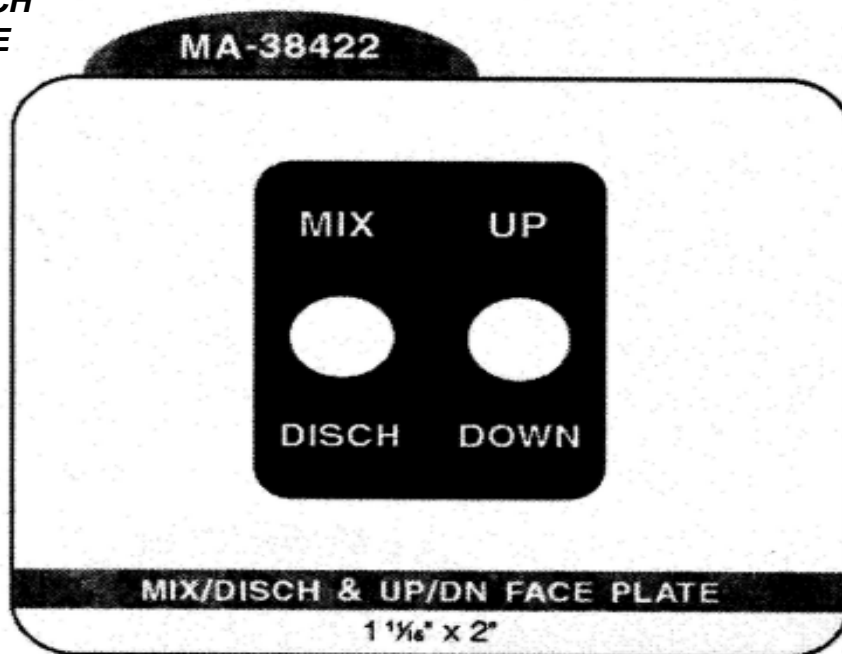

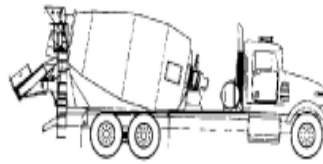

ELECTRICAL

**McNeilus
Chute Centering
Prox Switch**

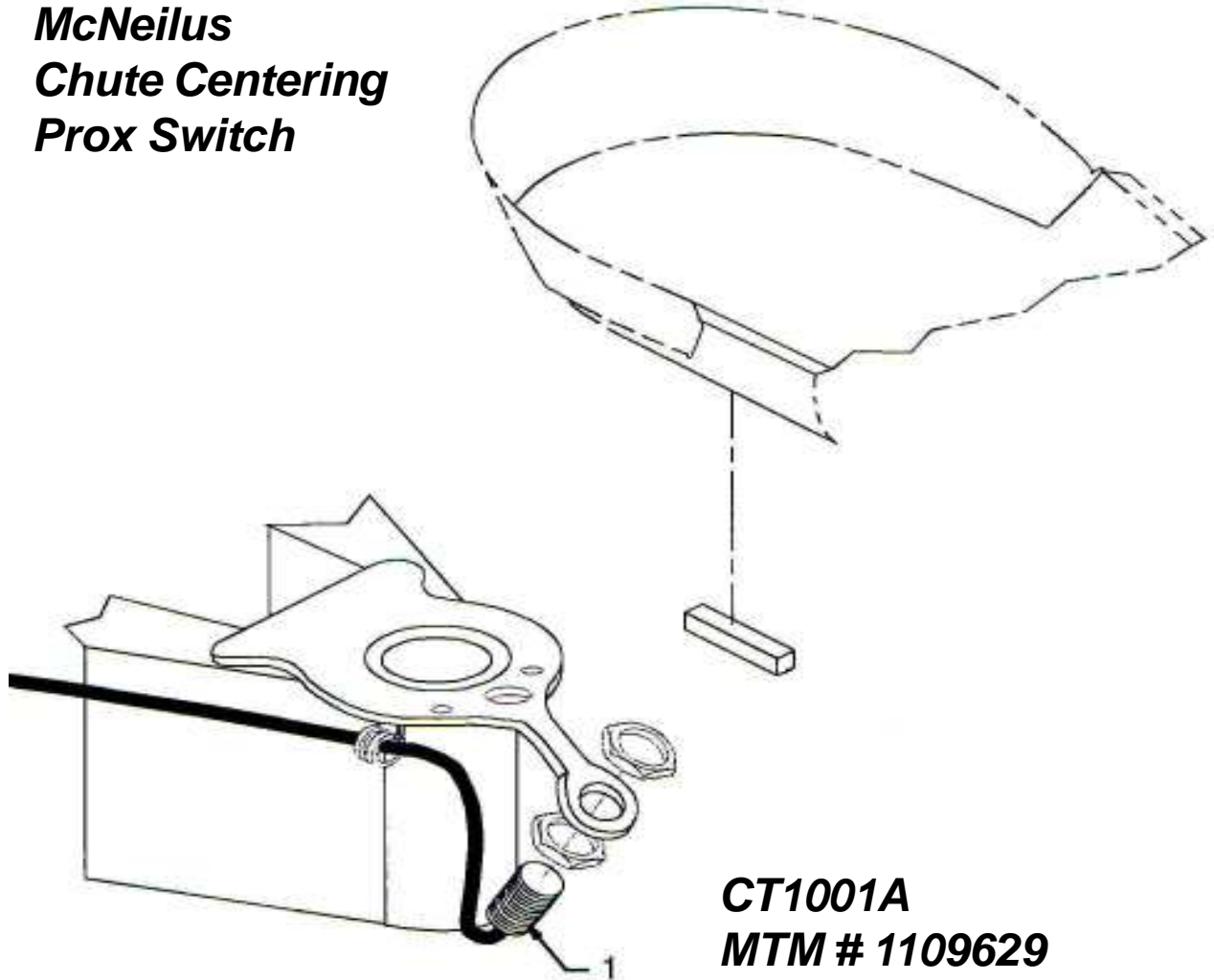

**CT1001A
MTM # 1109629**

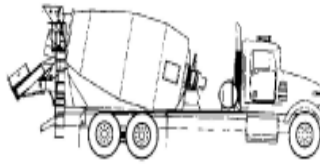

ELECTRICAL

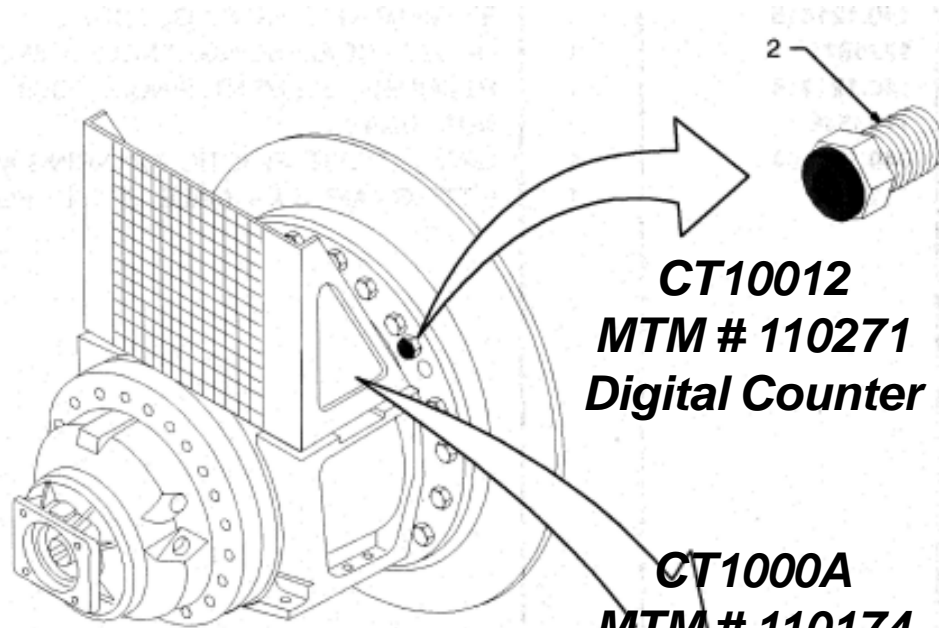

CT10012
MTM # 110271
Digital Counter

CT1000A
MTM # 110174
Pencil Prox Switch

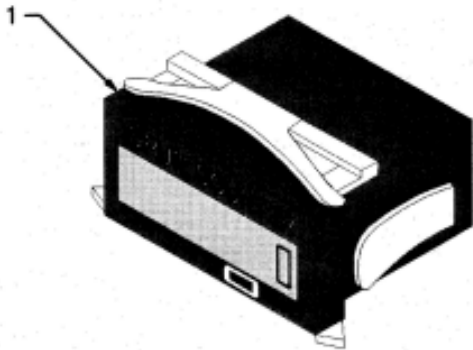

CT1004
MTM # 110173
Digital Counter

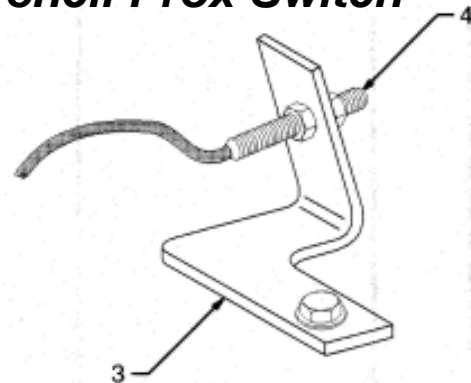

CT1005A
MTM # 500421
Prox Mount Brkt



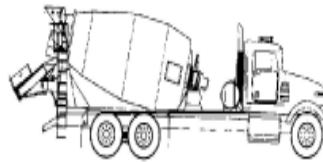

**Proximity
Switches**

ELECTRICAL



CT1000
MTM # 110198
2 Wire Prox Switch

CT1001
MTM # 110172
3Wire Prox Switch
with weatherpack

CT1000B
MTM # 110201A
Chute Center BM
4 Wire Relay Prox Switch
with weatherpack

CT1001A
MTM # 1109629
Chute Center BM
3 Wire Prox Switch
Short Body
with weatherpack

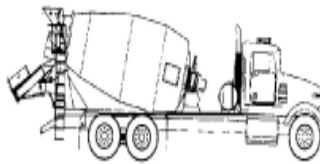

ELECTRICAL

**Continental
Electronics**

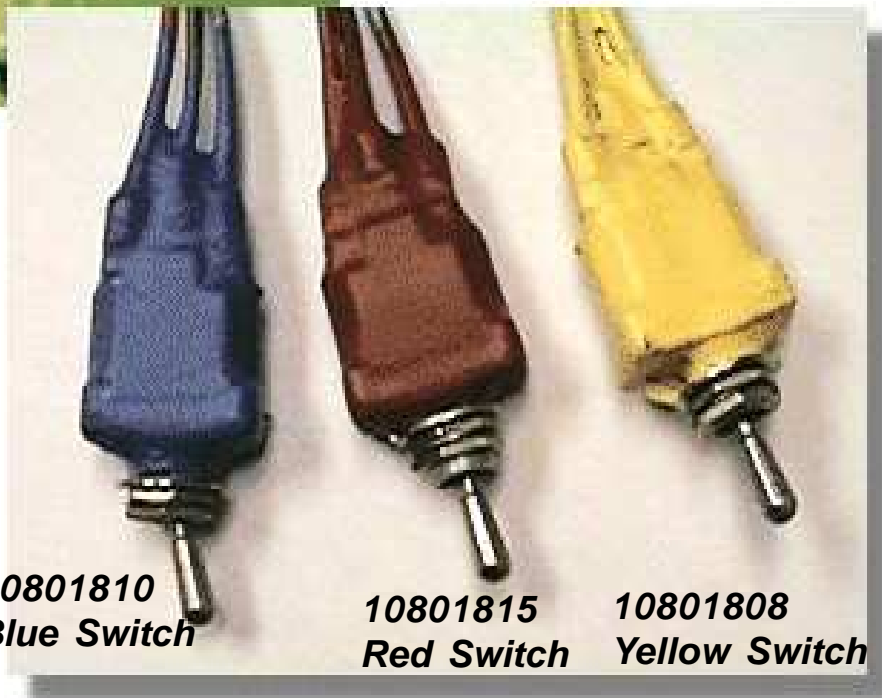

**10801810
Blue Switch**

**10801815
Red Switch**

**10801808
Yellow Switch**

Concrete Mixer Supply.com

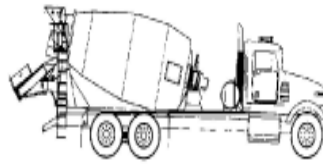

Mixer Parts

Continental
Electronics

ELECTRICAL



www.concretemixersupply.com

9-21

877-254-0715

Concrete Mixer Supply.com

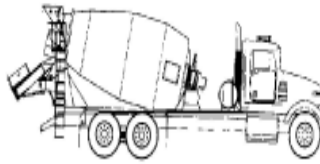

Mixer Parts

**Continental
Electronics**

ELECTRICAL

Concrete Mixer Supply.com

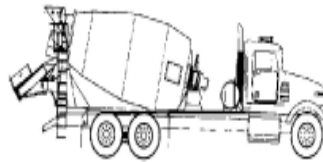

Mixer Parts

**CBMW Control Panel
Bridge Master Serial
99A69613767**

ELECTRICAL



**CSW1007
10802213
Chute Up/
Down
3 Spade**



**CSW1042
10802204
Chute Lock
5 Spade**



**CSW1042
10802204
Air Hopper
5 Spade**

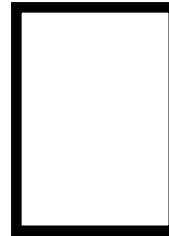

**CSW1041
10802215
Work Lite
5 Spade**

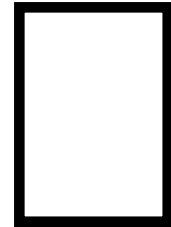

**CSW1041
10802215
Cooler
Override
3 Spade**



**CSW1040
10802214
Drum Stop
3 Spade**

Axle Go

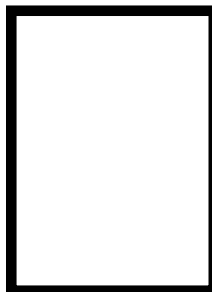

**CSW1043
10802203
Axle Stop
6 Spade**

Axle Up

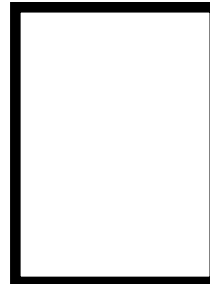

**CSW1043
10802203
Axle Down
6 Spade**

**Axle Up
Over-ride**

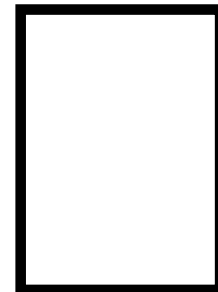

**CSW1043
10802203
Axle Down
Over-ride**



**CSW1043
10802203
Drum Rotation
Load/Unload
5 Spade**

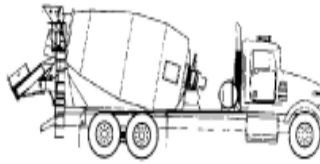

ELECTRICAL

**Advance Electrical
Components**



**23335 Advance
2 Switch Control**

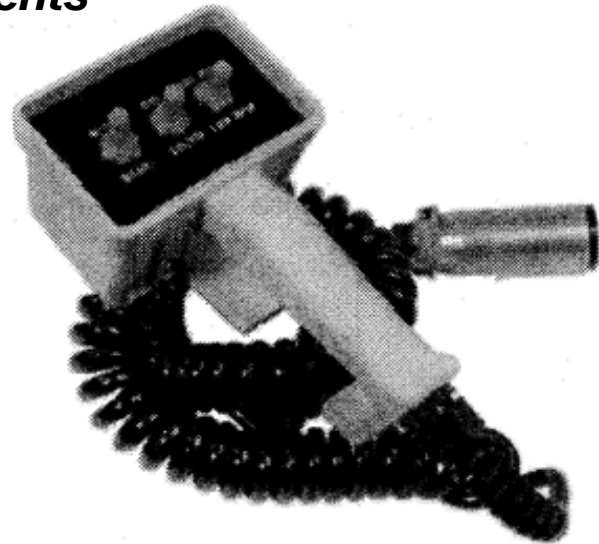

**29143 Advance
3 Switch Control**



**20297 & 20298
Advance Cab
Switches**

**CSW1000 On/Off
Switch 38416
CSW1001 Momentary
Switch 26602**

